

F60X 500

5 kg ... 500 kg

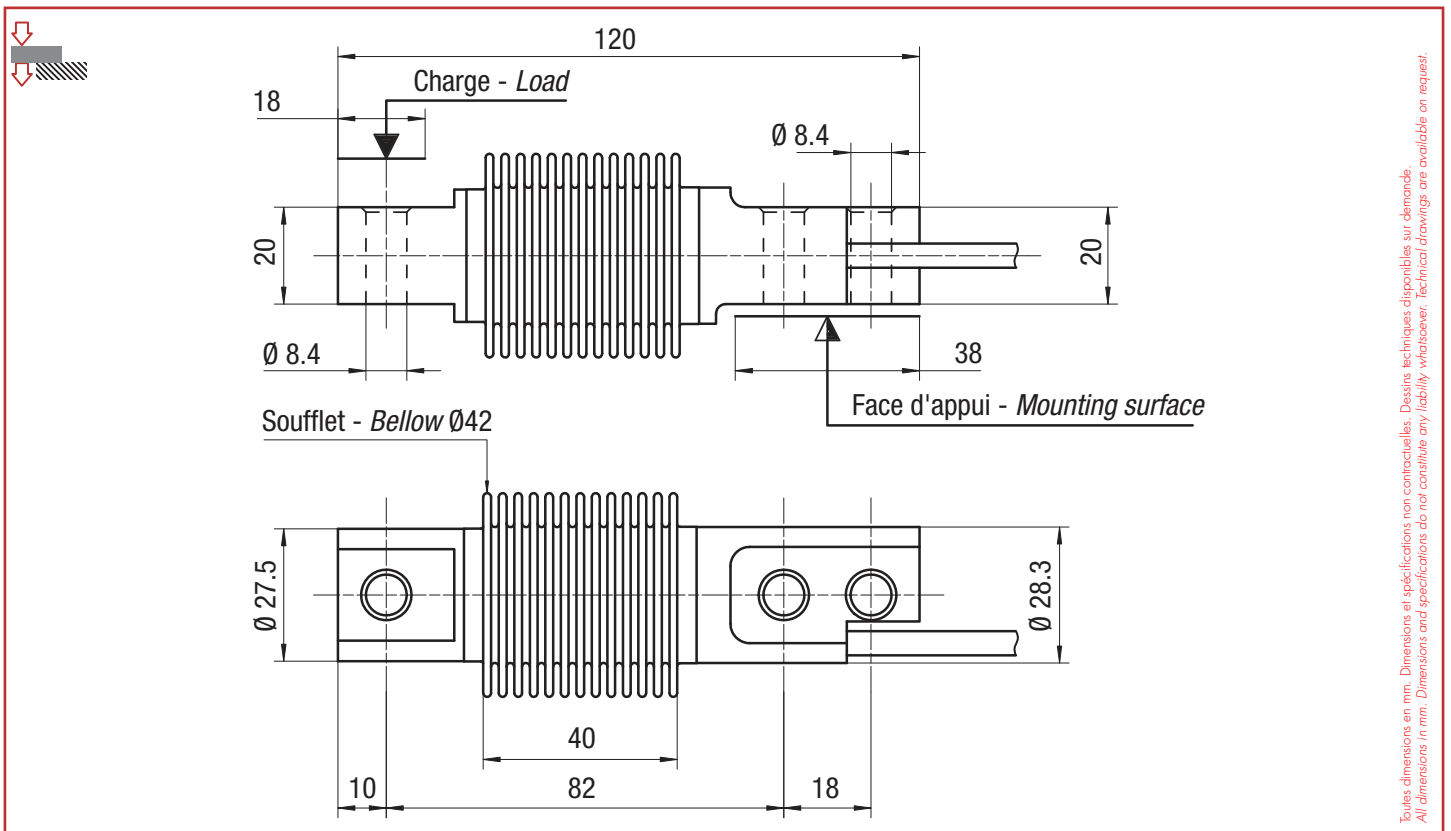

- Construction en acier inoxydable avec soufflet inox soudé IP68
- Homologué jusqu'à 6 000 d OIML
- Adapté au pesage industriel de haute précision
- Version optimisée pour l'ajustement des angles
- *Stainless steel construction hermetically sealed to IP68*
- *Up to 6 000 d OIML approved*
- *Ideally suited for any industrial weighing application where a high accuracy is needed*
- *Optimized alignment as an option*



Câblage - Wiring

+ alim.	+ signal	- signal	- alim.
+ excit.	+ signal	- signal	- excit.
rouge	noir	bleu	blanc
red	black	blue	white



F60X 500

5 kg ... 500 kg

Caractéristiques - Specifications

MÉTROLOGIQUES	METROLOGICAL	C1.5 3e 3	C3 10e	C6 10e	
Capacité nominale (Cn)	Rated capacity (Cn)	5	10, 20, 50, 100, 200, 300, 500		kg
Erreur combinée	Combined error	±0.033	±0.017	±0.008	%Cn
Effet de la temp. sur le zéro	Temperature effect on zero	±0.0042	±0.0014	±0.0014	%Cn/°C
Effet de la temp. sur la sensibilité	Temperature effect on sensitivity	±0.0019	±0.0014	±0.0007	%Cn/°C
Fluage (30 min.)	Creep error (30 min.)	±0.033	±0.025	±0.012	%Cn
Taille de plateau maximum	Maximum platform size	-	-	-	mm
MÉTROLOGIE LÉGALE OIML R60	LEGAL METROLOGY OIML R60				
Classe de précision	Accuracy class	C1.5	C3	C6	
Capacité maximale (E _{max})	Maximum capacity (E _{max})	6.6	13.1, 26.2, 65.5, 131, 262, 362, 602		kg
Nombre max. d'échelons (n _{max})	Max. number of LC intervals (n _{max})	1 500	3 000	4 000	d OIML
Échelon de vérification min. (v _{min})	Minimum verification interval (v _{min})	Cn/3 300	Cn/10 000	Cn/10 000	kg
Z=E _{max} /(2xDR)	Z=E _{max} /(2xDR)	1 500	3 000	6 000	
ÉLECTRIQUES	ELECTRICAL				
Plage de tension d'alimentation	Nominal range of excitation voltage		1 ... 15		V
Sensibilité nominale à Cn	Rated output at Cn		2 ±1% (option ±0.05 %)		mV/V
Plage de zéro initial	Zero balance		±2.5		%Cn
Résistance d'entrée/sortie	Input/output resistance		385 ±20 / 350 ±5		Ω
Résistance d'isolement	Insulation resistance		5 000		MΩ/50V
GÉNÉRALES	GENERAL				
Plage de temp. compensée	Compensated temperature range		-10 ... +40		°C
Plage de temp. de fonctionnement	Service temperature range		-20 ... +60		°C
Charge limite admissible	Safe load limit		150		%E _{max}
Charge ultime avant rupture	Ultimate overload		200		%E _{max}
Couple de serrage	Tightening torque		25		Nm
Degré de protection	Protection class		IP68		EN 60529
Matière	Material				
Corps d'épreuve	Measuring body				Acier Inox - Stainless Steel
Presse étoupe	Cable gland				
Gaine de câble	Cable sheath				
Longueur du câble	Cable length		3		m
Poids net	Net weight		0.45		kg

Options - Options

ATEX 2014/34/EU, IECEx

Ⓢ II 1 G/D, Ex ia IIC T6 Ga, Ex ia IIIC T80°C Da, IP6X, -20°C < Ta < +60°C (zone 0/20)

Ⓢ II 1 D, Ex ta IIIC T125°C Da, IP6X, -20°C < Ta < +60°C (zone 20)

Ⓢ II 3 G, Ex nA IIC T6 Gc, -20°C < Ta < +60°C (zone 2)

Accessoires - Accessoires

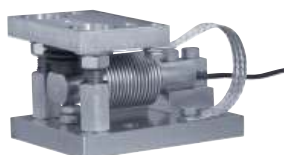

Stabiflex F



Pied - Foot LFC



MTPFA



Rubberkit

scaimé

Siège Social - Headquarter: Technosite Altéa - 294, Rue Georges Charpak - 74100 JUVIGNY - FRANCE

SCAIME SAS - 294, RUE GEORGES CHARPAK - CS 50501 - 74105 ANNEMASSE CEDEX - FRANCE

Tél. : +33 (0)4 50 87 78 64 - Fax : +33 (0)4 50 87 78 46 - info@scaimé.com - www.scaimé.com

Téléchargez tous nos documents sur notre site internet - Download all our documents on our website

